



| P115

MINIFACTOR™



Features

- UL508 Recognized and load break rated for 1000Vdc systems
- Hermetically sealed contactor: ensures make/break switching up to 1200Vdc
- Best option for: NEC 690.11 and 690.12 DC arc fault interrupting and rapid shutdown requirements
- Small, lightweight and cost effective patented design
- Perfect choice for 600Vdc and 1000Vdc photovoltaic/battery systems



SPECIFICATIONS

Specifications	Units	Data
Contact Arrangement	Form X	SPST-NO
Dielectric at Sea Level	Vrms	4300
Contact Voltage, Operating Max	Vdc	1500
Continuous Current Carry, Max (8 AWG)@ 25°C	A	50
Continuous Current Carry, Max (8 AWG)@ 85°C	A	25
Mechanical Life	Cycles	1,000,000
Contact Voltage Drop, Max @ 50A	mV	100
Contact Resistance, Max @ 50A (after 30 sec)	mOhms	3.25
Operate Time, Max	ms	25
Release Time, Max	ms	8
Vibration, Sinusoidal (50-200Hz Peak)	G	5
Shock, Operating, 1/2 Sine, 11ms	G	20
Temperature, Operating Range 1/	°C	-40° to +65°
Humidity, No Freezing or Condensing at Low Temperature	RH	5% to 85%
Weight	grams	135
Short Circuit Current Withstanding (5ms)	A	400
Impulse Withstand Voltage: IEC61000-4-4 (500 ohm)	kV	6

COIL RATINGS @ 25°C ²

Coil P/N Designation	B	C	F
Coil Voltage Nominal	12 Vdc	24 VDC	48 Vdc
Coil Voltage Max	16 Vdc	32 Vdc	64 Vdc
Pick-up, Volts, Max	7.5 Vdc	15 Vdc	30 Vdc
Drop-out, Volts, Max	5 Vdc	9 Vdc	18 Vdc
Drop Out Voltage, Min	0.20 Vdc	0.40 Vdc	0.80 Vdc
Coil Resistance, +/-10%	70 Ohms	280 Ohms	1092 Ohms
Coil Current at Nominal Voltage	0.170 A	0.085 A	0.045 A
Recommended External Coil Suppression (not included)	SMAJ40CA or P6KE47CA-E3/54	SMAJ40CA or P6KE47CA-E3/54	SMAJ100CA or P6KE120CA



POWER SWITCHING



CURRENT CARRY RATINGS

DC RESISTIVE CLOSING CYCLE ESTIMATES

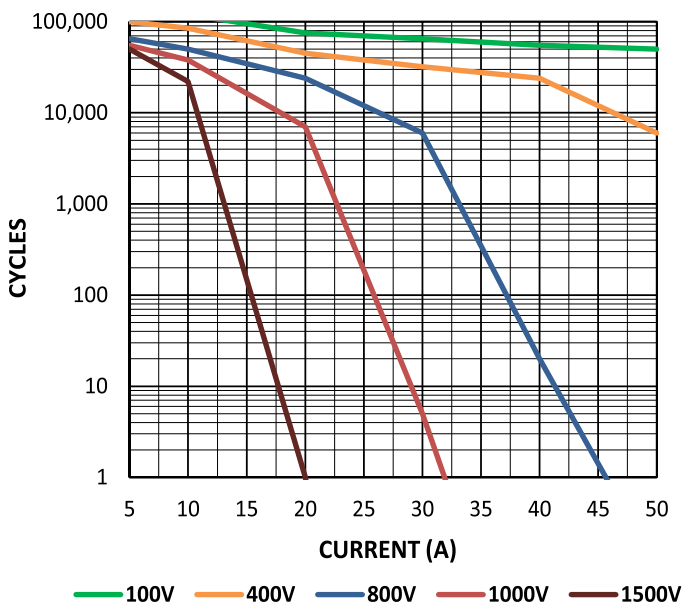

CURRENT CARRY vs TIME

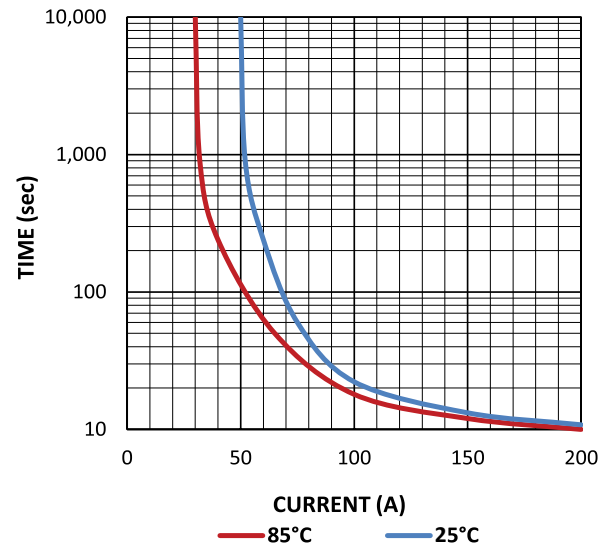



DIMENSIONS

All dimensions are +/- 0.5mm

Mounting

M4 or 8-32 Screws
Torque 1.3-1.7Nm [12-15in-lb]

Case Material

Thermoplastic Polyester Resin

Power Connection

M4 Studs
Torque 1.3-1.7Nm [12-15in-lb] max

Coil Termination

M3 Studs
Torque 0.5Nm [5in-lb] max

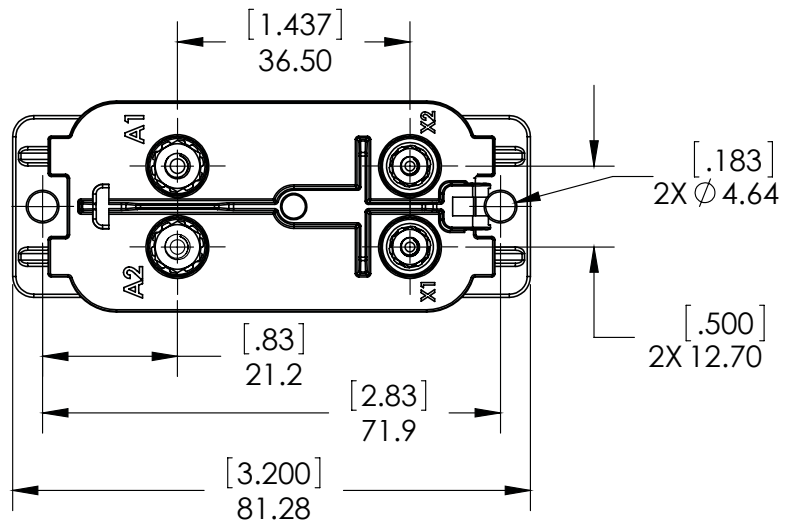
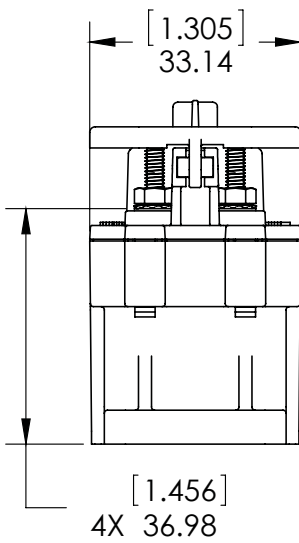
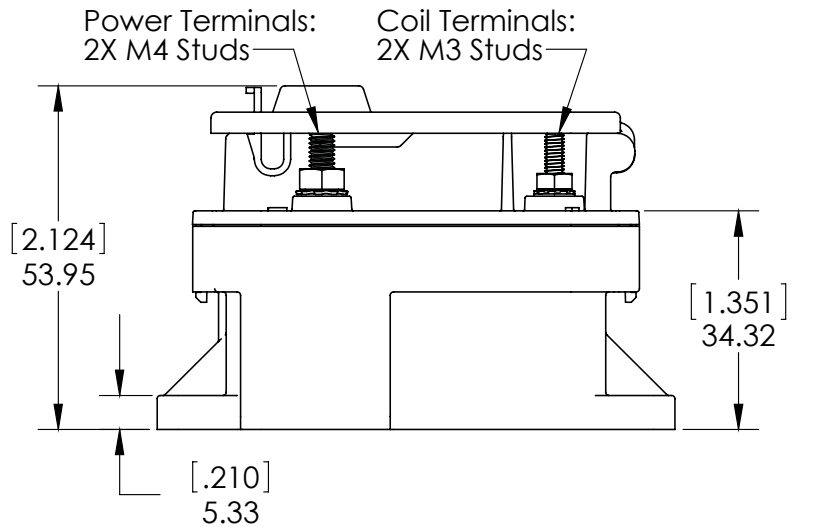

ORDERING OPTIONS

Example : P115BDA

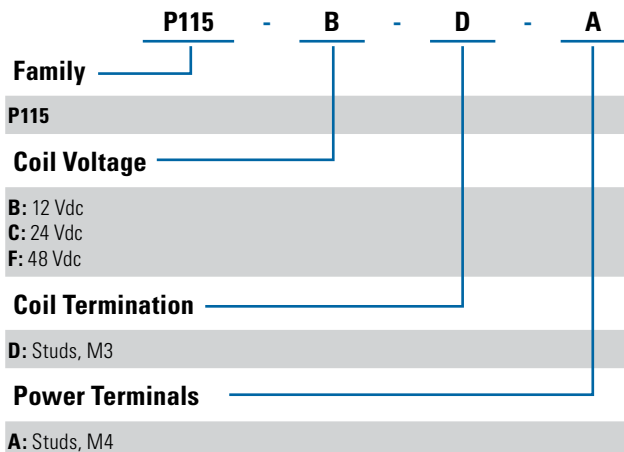



GENERAL NOTES

1. Temperature range refers to ambient conditions. Terminal temperature can exceed listed values.
2. Contactor is operated by a coil that changes resistance with temperature. Since pick-up current, coil current and coil power are specified at nominal voltage, they will be lower than indicated at temperatures above 25°C and higher than indicated at temperatures below 25°C. Similarly, pick-up and drop-out voltages will be higher than indicated at temperatures above 25°C and lower than indicated at temperatures below 25°C.



APPLICATION NOTES

- Electrical life rating is based on resistive load with 27µH maximum inductance in circuit. Because your application may be different, we suggest you test the contactor in your circuit to verify life is as required.
- Contactor is bi-directional and therefore can carry, make, and break current in both directions.
- Contactor is not sensitive to direction of installation and can be mounted in any position or axis.



WARNINGS



RISK OF MATERIAL DAMAGE AND HOT ENCLOSURE

- The product's side panels may be hot, allow the product to cool before touching
- Follow proper mounting instructions including torque values
- Do not allow liquids or foreign objects to enter this product

Failure to follow these instructions can result in serious injury, or equipment damage.



HAZARD OF ELECTRIC SHOCK, EXPLOSION OR ARC FLASH

- Disconnect all power before installing or working with this equipment
- Verify all connections and replace all covers before turning on power

Failure to follow these instructions will result in death or serious injury.

Sensata Technologies, Inc. ("Sensata") data sheets are solely intended to assist designers ("Buyers") who are developing systems that incorporate Sensata products (also referred to herein as "components"). Buyer understands and agrees that Buyer remains responsible for using its independent analysis, evaluation and judgment in designing Buyer's systems and products. Sensata data sheets have been created using standard laboratory conditions and engineering practices. Sensata has not conducted any testing other than that specifically described in the published documentation for a particular data sheet. Sensata may make corrections, enhancements, improvements and other changes to its data sheets or components without notice.

Buyers are authorized to use Sensata data sheets with the Sensata component(s) identified in each particular data sheet. HOWEVER, NO OTHER LICENSE, EXPRESS OR IMPLIED, BY ESTOPPEL OR OTHERWISE TO ANY OTHER SENSATA INTELLECTUAL PROPERTY RIGHT, AND NO LICENSE TO ANY THIRD PARTY TECHNOLOGY OR INTELLECTUAL PROPERTY RIGHT, IS GRANTED HEREIN. SENSATA DATA SHEETS ARE PROVIDED "AS IS". SENSATA MAKES NO WARRANTIES OR REPRESENTATIONS WITH REGARD TO THE DATA SHEETS OR USE OF THE DATA SHEETS, EXPRESS, IMPLIED OR STATUTORY, INCLUDING ACCURACY OR COMPLETENESS. SENSATA DISCLAIMS ANY WARRANTY OF TITLE AND ANY IMPLIED WARRANTIES OF MERCHANTABILITY, FITNESS FOR A PARTICULAR PURPOSE, QUIET ENJOYMENT, QUIET POSSESSION, AND NON-INFRINGEMENT OF ANY THIRD PARTY INTELLECTUAL PROPERTY RIGHTS WITH REGARD TO SENSATA DATA SHEETS OR USE THEREOF.

All products are sold subject to Sensata's terms and conditions of sale supplied at www.sensata.com SENSATA ASSUMES NO LIABILITY FOR APPLICATIONS ASSISTANCE OR THE DESIGN OF BUYERS' PRODUCTS. BUYER ACKNOWLEDGES AND AGREES THAT IT IS SOLELY RESPONSIBLE FOR COMPLIANCE WITH ALL LEGAL, REGULATORY AND SAFETY-RELATED REQUIREMENTS CONCERNING ITS PRODUCTS, AND ANY USE OF SENSATA COMPONENTS IN ITS APPLICATIONS, NOTWITHSTANDING ANY APPLICATIONS-RELATED INFORMATION OR SUPPORT THAT MAY BE PROVIDED BY SENSATA.

Mailing Address: Sensata Technologies, Inc., 529 Pleasant Street, Attleboro, MA 02703, USA.

CONTACT US

Americas
+1 (805) 684-8401
gigavac@sensata.com