

0857 DEUTSCH CONNECTOR ASSEMBLY

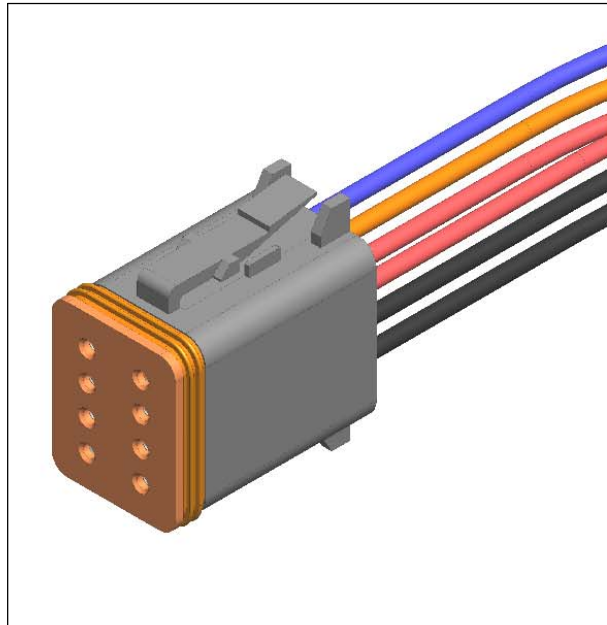

**FOR USE WITH GX AND MX SENSING CONTACTORS
FEATURING INTEGRATED DT08 DEUTSCH CONNECTOR**

GIGAVAC[®]
ADVANCED SWITCHING SOLUTIONS

0857 (ASSEMBLED)

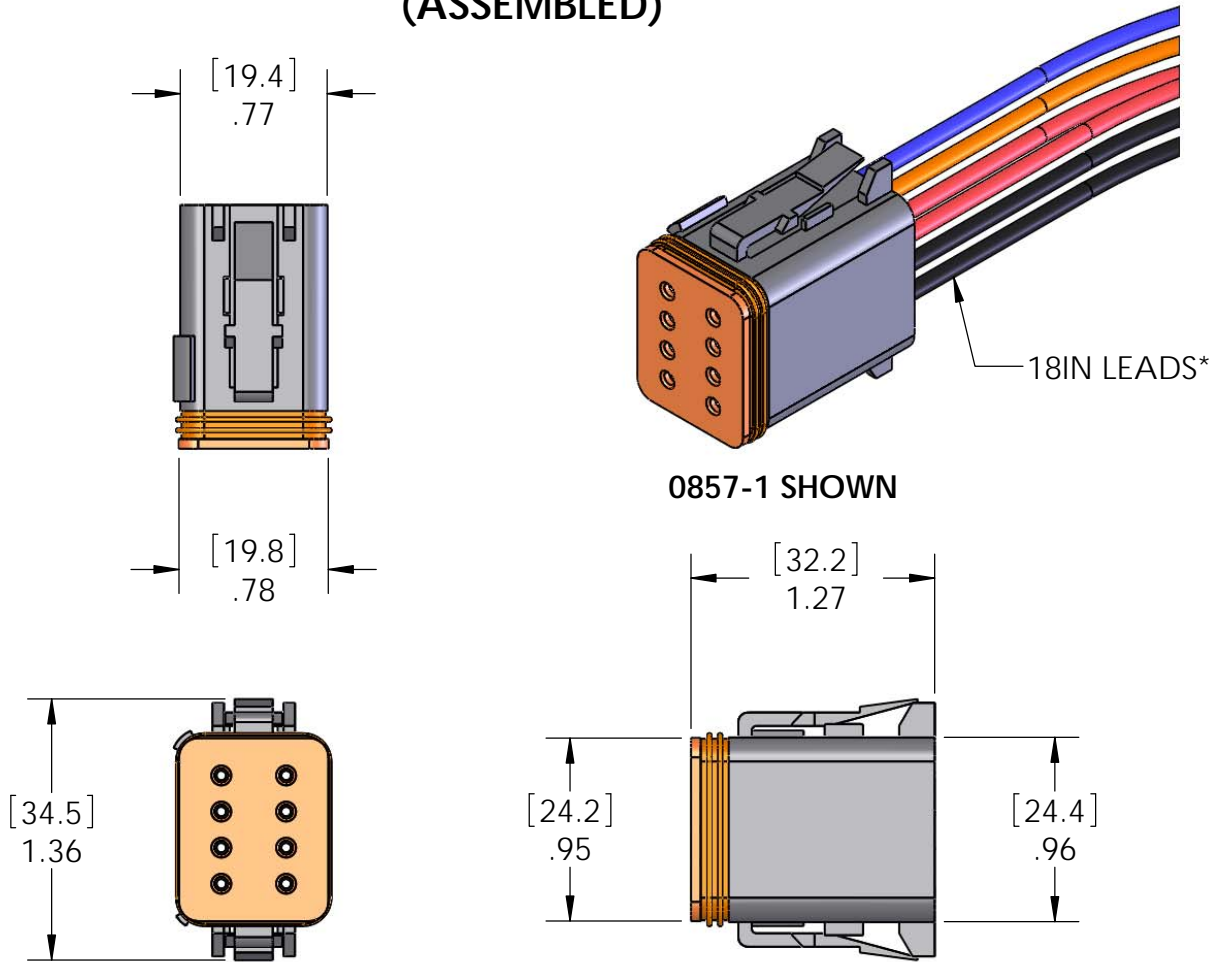

<u>PART NUMBER</u>	<u>DESCRIPTION</u>
0857-1	CURRENT SENSE
0857-2	CURRENT SENSE WITH AUXILIARY
0857-3	OVER CURRENT
0857-4	OVER CURRENT WITH AUXILIARY
0857-5	LOW VOLTAGE DISCONNECT
0857-6	LOW VOLTAGE DISCONNECT WITH AUXILIARY
0857-7	DELAY ON BREAK
0857-8	DELAY ON BREAK WITH AUXILIARY
0857-9	CAN-BUS
0857-10	CAN-BUS WITH AUXILIARY

SEE SHEET 3 FOR PINOUT CONFIGURATIONS

MATING CONNECTOR

DEUTSCH CONNECTOR HOUSING P/N: DT06-08SA
 SOLID CONTACT SOCKET P/N: 0462-201-16141
 WEDGE LOCK P/N: W8S
 SEALING PLUG P/N: 114017

LEADS*

UL3239 20AWG WIRE, 18 INCHES

PINOUT CONFIGURATIONS

0857-1
Current Sense

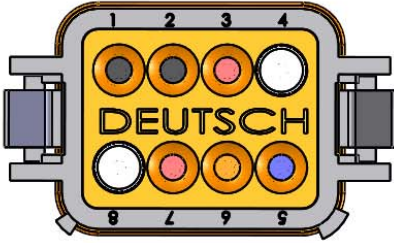

0857-2
Current Sense with Auxiliary

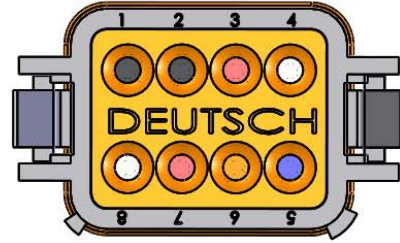

0857-3
Over Current

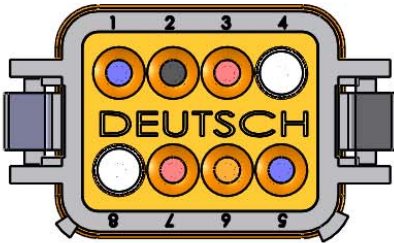

0857-4
Over Current with Auxiliary

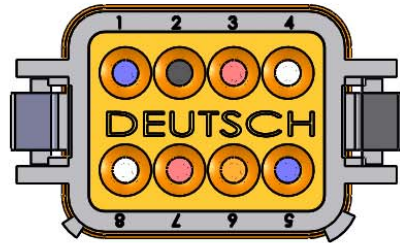

0857-5
Low Voltage Disconnect

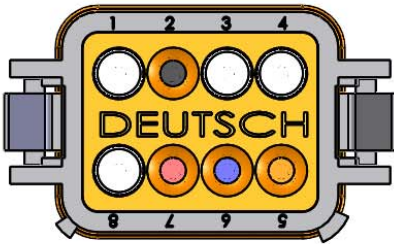

0857-6
Low Voltage Disconnect with Auxiliary

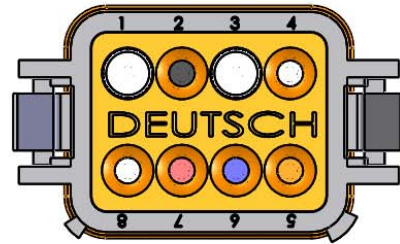

0857-7
Delay on Break

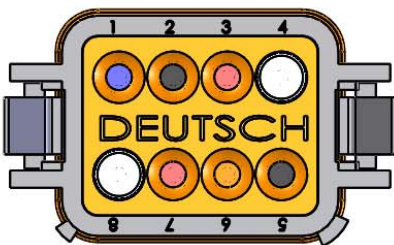

0857-8
Delay on Break with Auxiliary

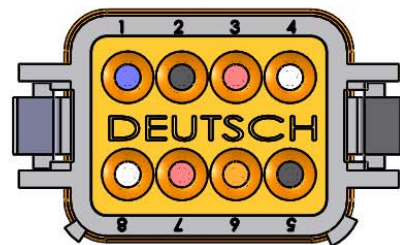

0857-9
CAN-Bus

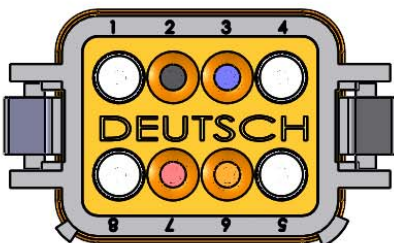

0857-10
CAN-Bus with Auxiliary

